

PERFECT FIRST CUT



Panel Saw

We support to provide

- The high quality production
- The high efficiency product
- The reliable product
- The specialized consulting & engineering
- The expert after – sales service.



Sliding Table Saw

Model : STS -190D/260D/320D/380D



Application

The STS series Sliding Table Saw are one of the blade tilts cutting precise machines.

Which both have a sliding table for easy running and guided with absolute precision.

The miter fence and miter saw blade make the users designing and creating different product.

The STS are necessary for any small and large company to cutting and trimming the panels and /or solid wood.

They are wide used for System cabinet OA furniture \ Kitchen cabinet \ Computer table \ Living room TV & Stereo case and the other wooden furniture industry.

Features

- User friendly front panel power design, both fro control system and saw unit.
- Main and scoring saw blade ensures tear-free cutting.
- Saw blade guard, attach to riving knife to ensure safety.
- Blade tilts 45 for miter cutting.
- Miter fence can be positioned at 45 right and left.
- Miter fence is attached with a scale calibrated in imperial and metric size.
- Thick power coated sheet metal extension to avoid falling of cut piece.
- Table extension on right and rear side of main table permits convenient cutting for large panel.

DIMENSION

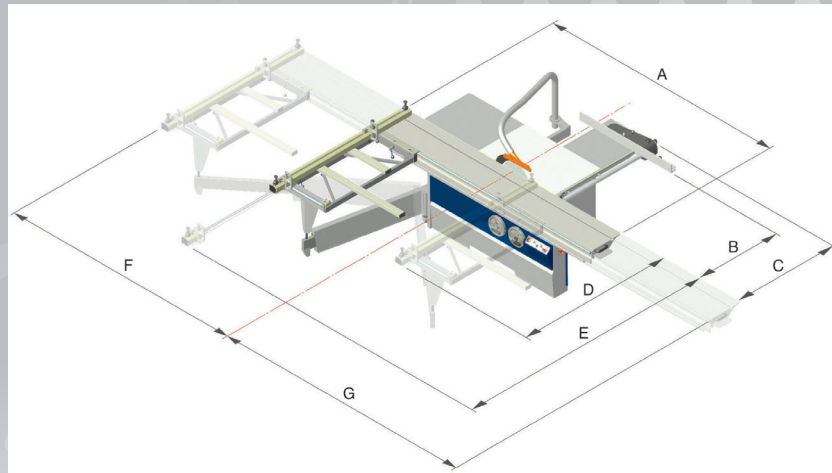

NO	STS-190D	STS-260D	STS-320D	STS-380D
A	1900 mm	2600 mm	3200 mm	3800 mm
B	1000 mm	1300 mm	1300 mm	1300 mm
C	1225 mm	1525 mm	1525 mm	1525 mm
D	1820 mm	1820 mm	1820 mm	1820 mm
E	Max. 3215 mm	Max. 3215 mm	Max. 3215 mm	Max. 3215 mm
F	2240 mm	2940 mm	3540 mm	4140 mm
G	2160 mm	2860 mm	3460 mm	4060 mm

TECHNICAL DATA

Model		STS-190D	STS-260D	STS-320D	STS-380D
Sliding Table dimension		1900 x 380	2600 x 380	3200 x 380	3800 x 380
Max.Sliding stroke w / crosscut fence		1900	2600	3200	3800
Table size(table w / ext.wing)		570 x 1000	570 x 1000	570 x 1000	570 x 1000
Main saw	Max.saw blade diameter	355	355	355	400
	Saw blade arbor diameter	30	30	30	30
	Cutting height at 90.45	105 / 73	105 / 73	105 / 73	125 / 88
	Motor power	5 HP	5 HP	5 HP	7.5HP
	Spindle rotation	3000 / 4000 / 5000	3000 / 4000 / 5000	3000 / 4000 / 5000	3000 / 4000 / 5000
Scoring saw	Saw blade diameter	120	120	120	120
	Saw blade arbor diameter	22	22	22	22
	motor power	0.75 HP	1 HP	1 HP	1 HP
	Spindle rotation	8000	8000	8000	8000
Crosscut width		1000	1300	1300	1300
Blade tilting adjustment		0-45°	0-45°	0-45°	0-45°
Dust collection system		4"	4"	4"	4"
N.W. / G.W. Measurement	Machine size	2270 x 1300 x 360	2270 x 1300 x 1010	2270 x 1300 x 1010	2270 x 1300 x 1010
	N.W. / G.W.	600 / 780	600 / 780	600 / 780	600 / 780
	Sliding table size	2030 x 470 x 360	2730 x 470 x 360	3330 x 470 x 360	3930 x 470 x 360
	N.W. / G.W.	103 / 135	167 / 227	187 / 247	207 / 267

PANEL SAW

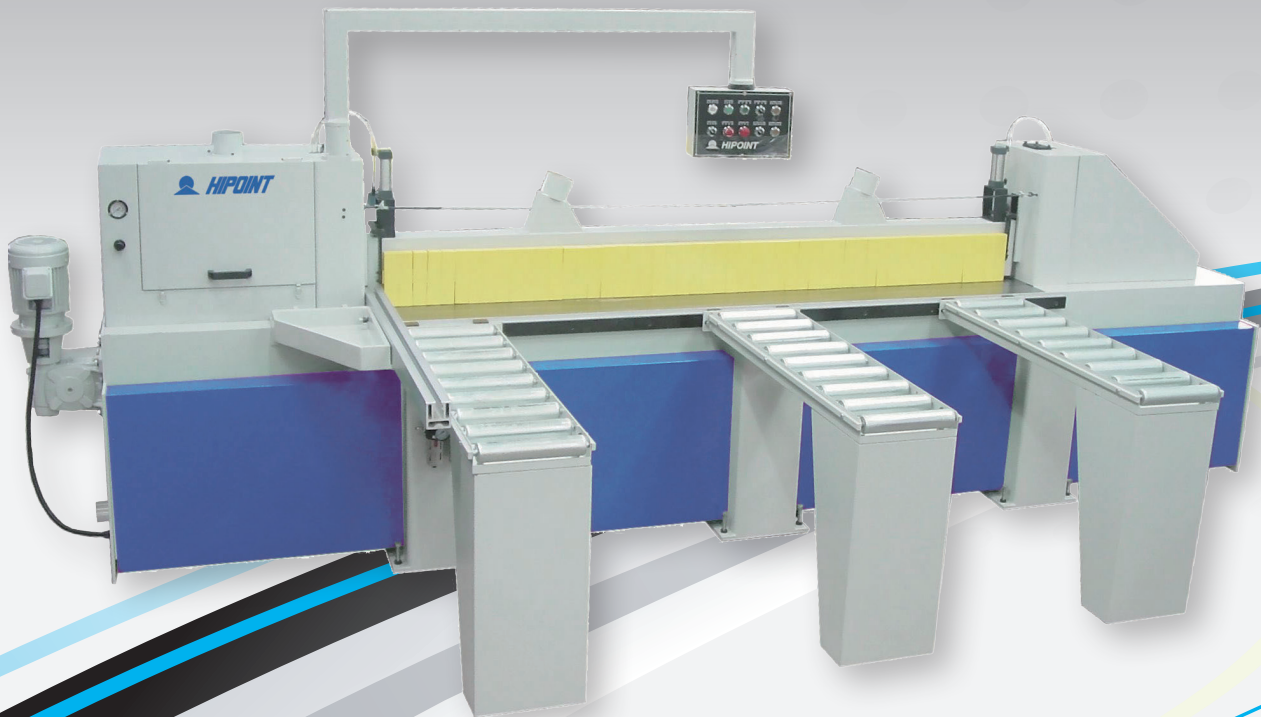

Application

The Panel Saw (as know as Horizontal Beam Saw, Running Saw) are designed for cutting panel to require size.

The manual Panel Saw, Panel loading in front of machine and unloading at the back of machine, which using mechanical stop to set the cutting size.

The Panel Saw is widely used for system cabinet OA furniture 、Kitchen cabinet 、 Computer table 、 Living room TV & Stereo case and other wooden furniture industry.

Features

- Heavy and rigid constructure to ensure high cutting accuracy and productivity.
- Standard equipped with scoring saw unit to obtain the best finishing cut on any kind of panel.
- Lifting and lowering of saw carriage is pneumatically controlled, the moving stroke.

Standard Attachment

- (1) Pcs of main saw blade: 355 mm x 3.2 mm x 50 T
- (1) Pcs of scoring saw blade: 160 mm x 3.1~4.5 mm x 40 T
- (3) Set of infeed roller table, 1200 x 300 mm
- (3) Set of outfeed table, 1200 x 300 mm
- (2) Pcs of scoring saw blade motor belt :
20 mm x 1630 mm (1 in the machine, another in the tool box)
- (1) Set of piano-key type dust guard
- (2) Pcs of panel position cylinder
- (1) Set of tool box
- (1) Set of operation manual

Optional Attachment

- Main saw motor 15HP instead of 13HP
- Air floating table w/o fence, 1200 x 300 mm
Instead of roller table.
- Pneumatic position device (2 pcs air cylinder per set)
- Pneumatic position device (3 pcs air cylinder per set)
- Jumping device for postformed strip

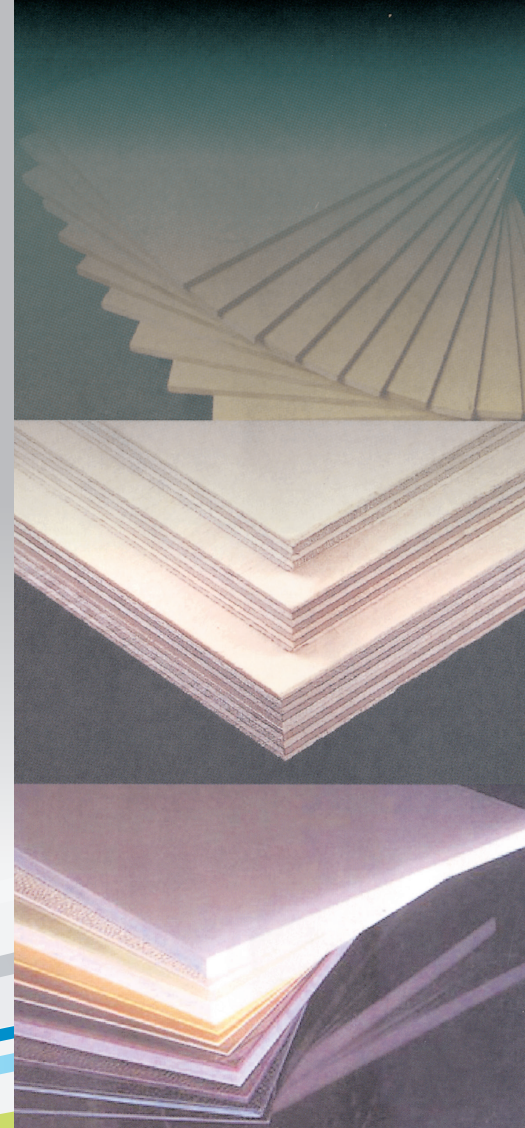

Model		PSW-1300	PSW-2600	PSW-3200
Max.cutting length	mm	1300	2600	3200
Max.cutting thickness	mm	80	80	80
Main saw motor	hp	13	13	13
Main saw blade diameter	mm	355	355	355
Main saw arbor diameter	mm	25.4	25.4	25.4
Main saw rotation	rpm	4800	4800	4800
Scoring saw blade diameter	mm	160	160	160
Scoring saw arbor diameter	mm	25.4	25.4	25.4
Scoring saw rotation	rpm	6500	6500	6500
Feeding motor	hp	3	3	3
Feeding speed(forward)	m/min	12-16-21-26	12-16-21-26	12-16-21-26
Feeding speed(backward)	m/min	24-32-42-52	24-32-42-52	24-32-42-52
Working air pressure	kg/cm	41765	41765	41765
Table height from floor	mm	850	850	850
Net weight	kgs	1500	2200	2400
Gross weight	kgs	1850	2400	2900

Computer Panel Saw

Application

The panel saw (as known as Horizontal Beam Saw, Running Saw) are designed for cutting panels to required size.

Automatic Panel Saw, Panel loading in front of machine which using PLC control system memorize the cutting pattern and automatically cut to size according to the cutting pattern.

The Panel Saw is widely used for System cabinet, OA furniture, Kitchen cabinet, Computer table, Living room TV & Stereo case and other wooden furniture industry.

Features

- Heavy and rigid construction to ensure high cutting accuracy and productivity.
- Standard equipped with scoring saw unit to obtain the best finishing cut on any kind of panel saw.
- Top pressure beam is designed of the pneumatic lifting system with rack and pinion for simultaneously up and down.
- Lifting and lowering of saw carriage is pneumatically controlled. The moving stroke of saw carriage by sensor.
- Automatic machine is equipped with electronically controlled system which can memorize 500 different cutting partial for longitudinal and cross cutting.



**Precision high speed (100 m / min)
available on request**

Standard Attachment

- (1) Set of main saw blade: 405 mm x 80T x 4.0 mm x 1"
- (1) Set of scoring saw blade: 180 mm x 40 T x 3.9~5.2 mm x 1"
- (3) Set of air floating table, 1250 mm x 450 mm
- (1) Pcs of spare main saw belt: HDT 8 m x 35 mm x 1248 mm
- (2) Pcs of spare scoring saw belt: 20 mm x 1740 mm
- (1) Set of tool box
- (1) Set of operation manual
- FUJI 8.4" TFT Touch Screen
- Double pressure beam system
- Automatic positioning and push double side aligners
- PLC with 500 sets memory capacity.



Optional Attachment

- Main saw motor 20HP instead of 15HP
- PC control system with optimized cutting function
- Bar code printer allows for editing contents as requests



Positioning pusher with grippers
(Pneumatic clamp)

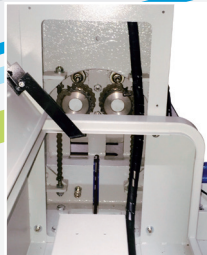

Double pressure beam

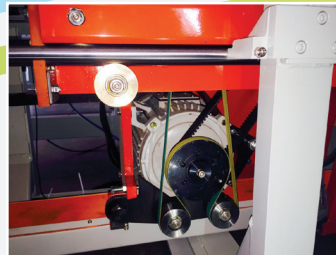

Main saw & scoring saw unit
The main saw motors 15HP.

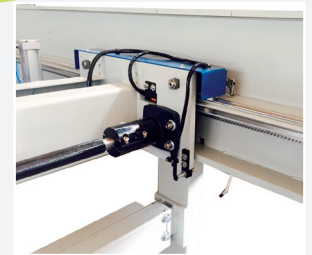

High precision sensors



Auto. lubrication system

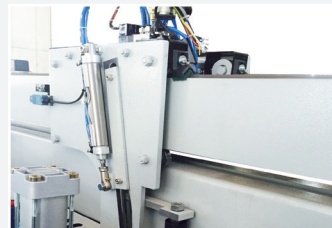
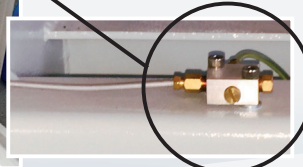

Pneumatic side alignment
device for cross cuts (rear side)



Pneumatic side alignment
device for cross cuts
(front side)

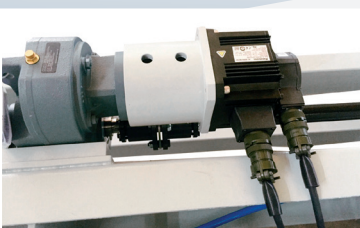

German made gear reducer plus
Japan made AC servo motor



PLC control system with 500
SETS memory capacity



PC control system with
optimized cutting function
(on request)



Bar code printer allows for
editing contents as
requests (on request)

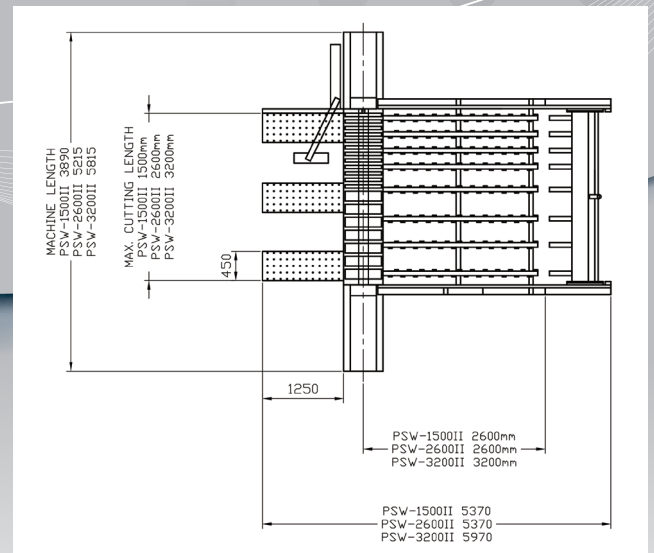
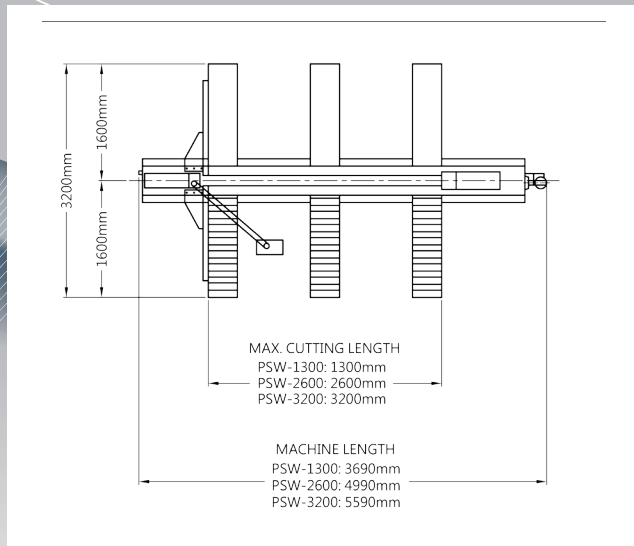

PSW-1300-2600-3200

PSW-1500II-2600II-3200II

Model		PSW-1500 II	PSW-2600 II	PSW-3200 II	PSW-3700 II
Max.cutting length	mm	1500	2600	3200	3700
Max.cutting thickness	mm	100	100	100	100
Main saw motor	hp	15 (20)	15 (20)	15 (20)	15 (20)
Main saw blade diameter	mm	405	405	405	405
Main saw arbor diameter	mm	φ 25.4	φ 25.4	φ 25.4	φ 25.4
Main saw rotation	rpm	4800	4800	4800	4800
Scoring saw blade diameter	mm	175	175	175	175
Scoring saw arbor diameter	mm	25.4 (30)	25.4 (30)	25.4 (30)	25.4 (30)
Scoring saw rotation	rpm	6500	6500	6500	6500
Feeding motor	hp	2	2	2	2
Feeding speed (forward)	m / min	5-45	5-45	5-45	5-45
Feeding speed (backward)	m / min	5-70	5-70	5-70	5-70
Gripper feed motor	hp	1.33	1.33	1.33	1.33
Gripper feed speed (forward)	m / min	5-70	5-70	5-70	5-70
Gripper feed speed (backward)	m / min	5-60	5-60	5-60	5-60
Working air pressure	kg / cm	41765	41765	41765	41765
Table height from floor	mm	900	900	900	900
Net weight	kgs	2700	4100	4500	4700
Gross weight	kgs	3050	4700	5100	5300
Air blower motor	hp	3	3	3	3



TECHNIK ASSOCIATES, INC.

No. 436, Sec. 3, Yatan Rd., Daya Dist., Taichung 42854, Taiwan.

Tel.: +886-4-2534-9000 • 2568-8555 Fax: +886-4-2534-9160

[http:// www.hipoint.com.tw](http://www.hipoint.com.tw)

E-mail: hipointmachinery@gmail.com / hptmac@gmail.com